



ROSETTA®
CHANGE YOUR VIEW

BELVEDERE TECH GUIDE



TABLE OF CONTENTS

Contents	2
Introduction	3
Block Details	4-5
Retaining Wall Construction Details	6-7
Wall Patterns - Retaining	8-9
Freestanding Wall Construction Details	10
Wall Patterns - Freestanding	11
Pillar Construction	12
Inside Step Installation	13
Corner Details	14
Curved Walls	15
Preliminary Height Guides	16-21
Typical Drain Placement Details	22
Associated Products	23



Thank you for your interest in installing Rosetta's exciting new Belvedere Collection. By combining the look and feel of natural weathered stone, with the dimensional consistency of concrete blocks, this premium line of hardscape products promises to give you **creative possibilities** never before available in an **engineered system**.

Because each Belvedere unit has a **beautiful stone texture** on both the front and back surfaces, the system provides an ideal solution for **garden walls, columns, free-standing walls, water-features, retaining walls** and more. The possibilities are truly endless.

Please take the time to familiarize yourself with this detailed technical guide. This valuable resource will give you the basic knowledge needed to create **stunning, quality landscape features** that will last for generations to come!

www.discoverrosetta.com/belvedere

WALL BLOCKS

Belvedere Collection wall blocks are provided in six basic sizes. The blocks are finished on the front and back faces. Both sides of the wall blocks are tapered on each side approximately 1" from the front to the back of the block. There are multiple face/texture patterns for each basic block size, providing a more random look for your finished project. Average block weights of the different face/texture patterns are shown. Weights of individual blocks may vary.

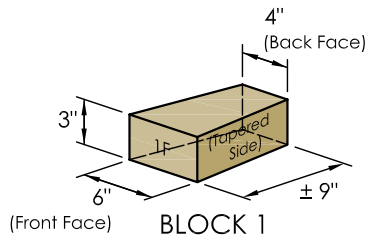

BLOCK 1

- Weight = ±10 lbs
- 12 per Pallet

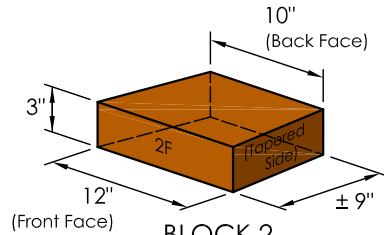

BLOCK 2

- Weight = ±22 lbs
- 12 per Pallet

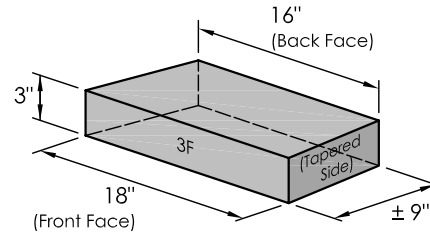

BLOCK 3

- Weight = ±36 lbs
- 12 per Pallet

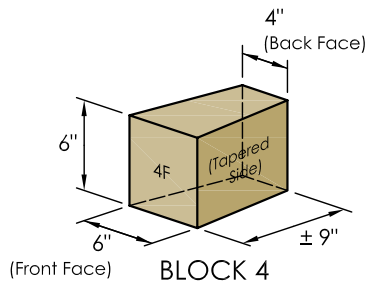

BLOCK 4

- Weight = ±21 lbs
- 12 per Pallet

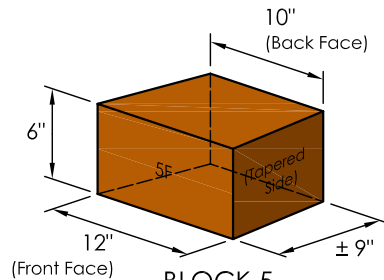

BLOCK 5

- Weight = ±42 lbs
- 12 per Pallet

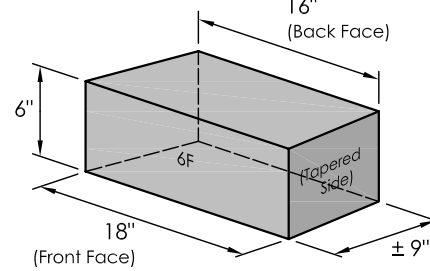

BLOCK 6

- Weight = ±67 lbs
- 12 per Pallet

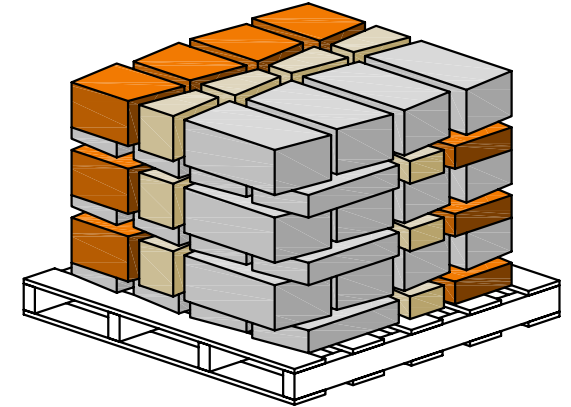

WALL PALLET

- Pallet weight = ± 2,475 lbs (incl. pallet weight)
- Coverage = ± 27 sft / Pallet when used in a Retaining Wall and ± 25 sft / Pallet when used in a Freestanding wall

Note: Blocks may be palletized upside down at some manufacturers.

CORNER BLOCKS

The Belvedere Collection contains 2 corner blocks sizes. The blocks are finished on 3 sides. The 4th side is tapered to fit with retaining wall blocks. The corner blocks can be used to construct columns, provide a finished end on a freestanding wall, and to make 90° corners. There are multiple face/texture patterns for both column blocks sizes, providing a more random look for your finished project. Average block weights of the different face/texture patterns are shown. Weights of individual blocks may vary.

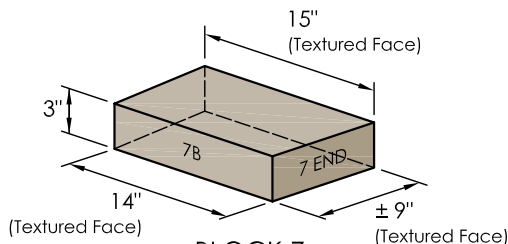

BLOCK 7

- Weight = ± 30 lbs
- 16 per Pallet

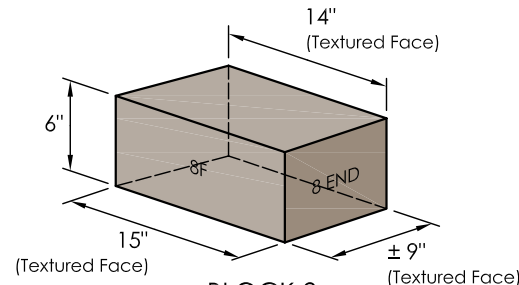

BLOCK 8

- Weight = ± 58 lbs
- 16 per Pallet

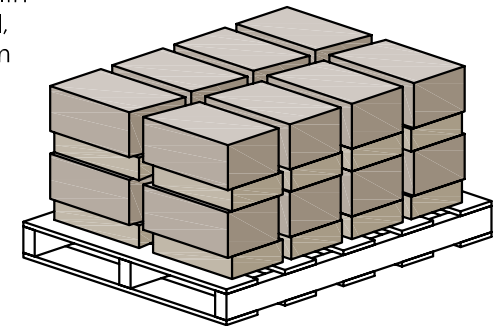

CORNER PALLET

- Pallet weight = ± 1,520 lbs (incl. pallet weight)
- Coverage = ± 24 sft / Pallet

COPING BLOCKS (CAPS)

Belvedere Collection coping blocks are provided in five basic sizes. There are three standard coping blocks which are finished on the front, back, and top faces. The standard coping blocks are tapered approximately 1" on each side from the front to the back of the block. There are also two end units which are finished on front, back, top, and one of the sides. The other side is tapered approximately 1" from the front to the back of the block. The end units are useful for constructing corners and ends. There are multiple face/texture patterns for each basic block size, providing a more random look for your finished project. Average block weights of the different face/texture patterns are shown. Weights of individual blocks may vary.

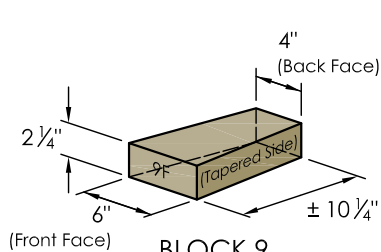

BLOCK 9

- Weight = ±9 lbs
- 24 per Pallet

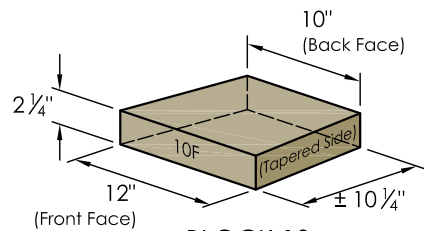

BLOCK 10

- Weight = ±20 lbs
- 24 per Pallet

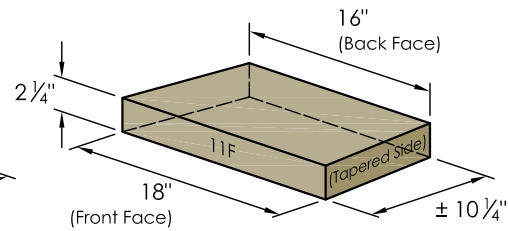

BLOCK 11

- Weight = ±30 lbs
- 12 per Pallet

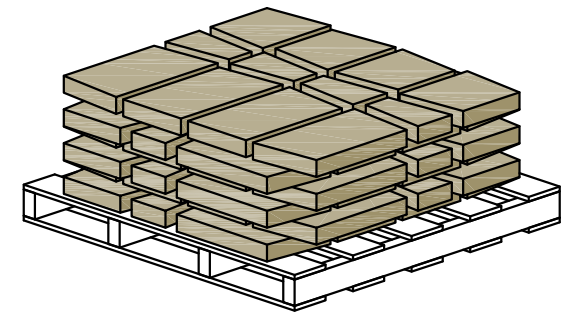

COPING PALLET

- Pallet weight = ± 1,550 lbs (incl. pallet weight)
- Coverage = ± 66 linear feet / Pallet

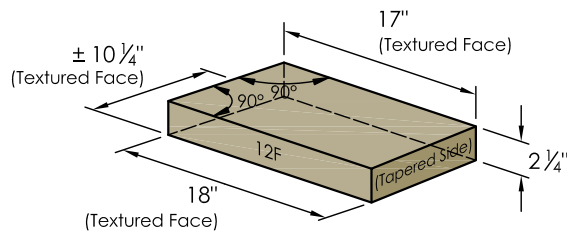

BLOCK 12

(Left End)

- Weight = ±29 lbs
- 6 per Pallet

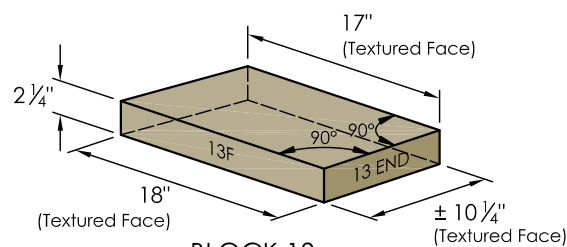

BLOCK 13

(Right End)

- Weight = ±34 lbs
- 6 per Pallet

COLUMN CAP BLOCKS

Belvedere Collection column cap blocks are provided to finish our standard built-up column. The 27" x 27" dimension provides an overhang of approximately 1 1/2" on all sides. The column cap can be cored for installation of lights or other features. Average block weights are shown. Weights of individual blocks may vary.

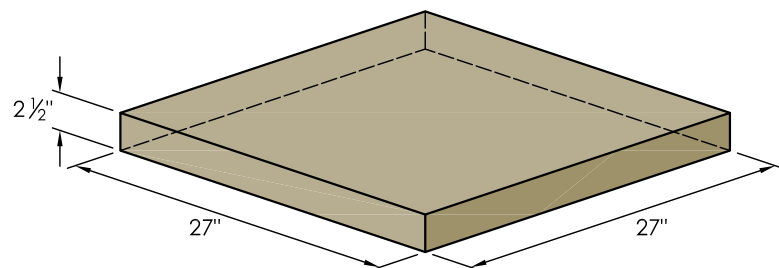

BLOCK 14

(Column Cap)

- Weight = ±150 lbs
- 10 per Pallet

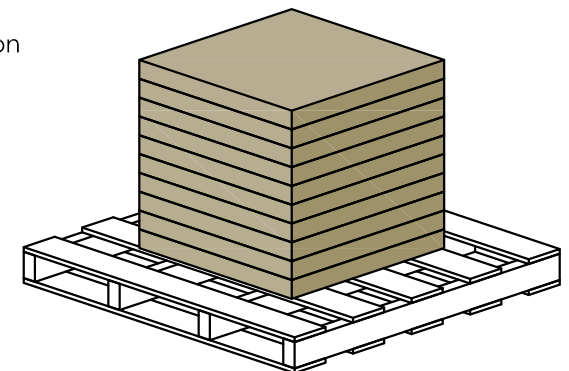

COLUMN CAP PALLET

- Pallet weight = ± 1,550 lbs (incl. pallet weight)
- Coverage = 10 caps

TYPICAL RETAINING WALL CONSTRUCTION DETAILS

This page shows typical construction details for Belvedere retaining walls. These drawings are representative of major components required in wall construction. Specific details including geotextile reinforcement layers, drainage details, soil requirements, etc. shall be per the engineered design for the wall.

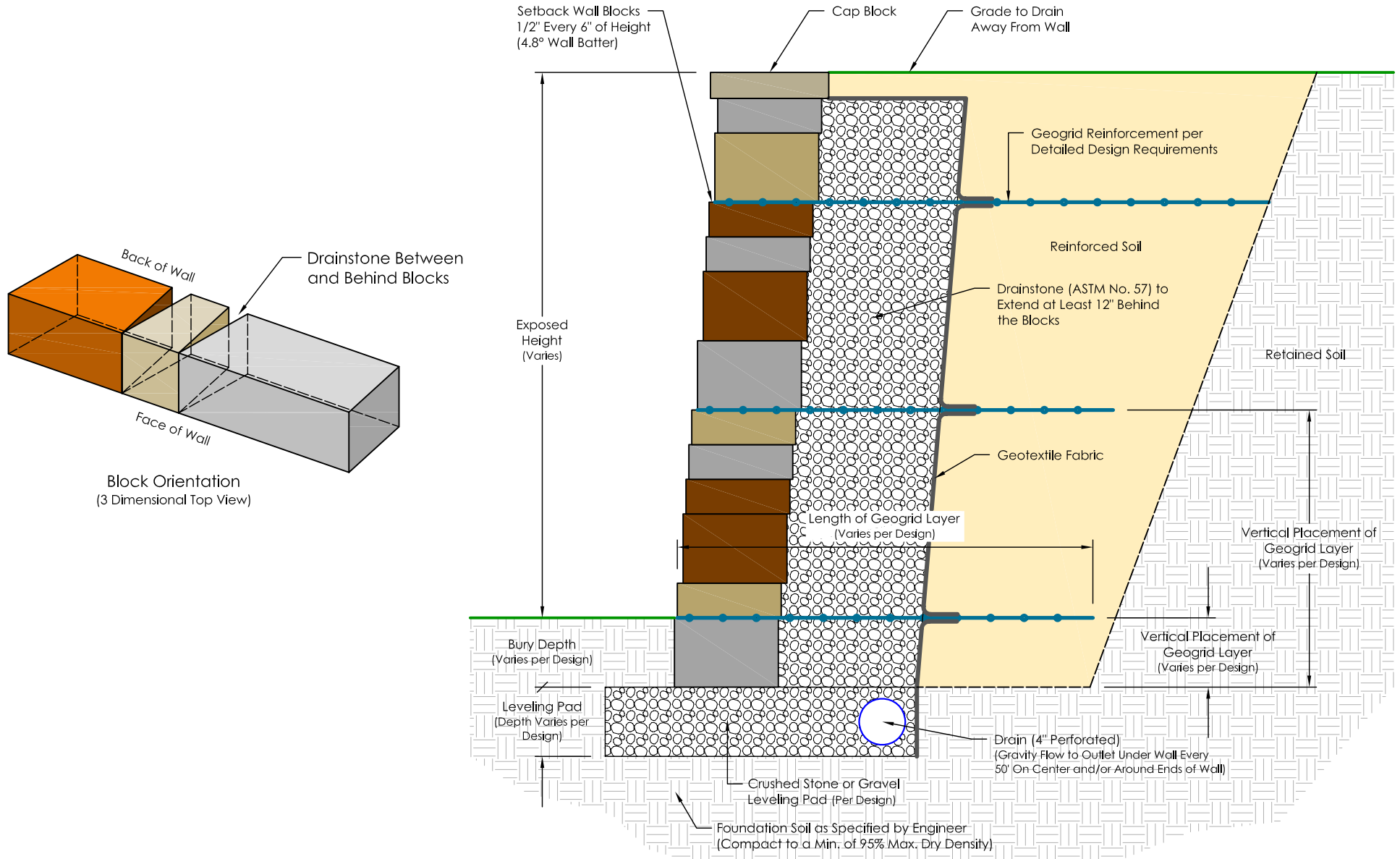

- This drawing is for reference only.
- Final designs for construction must be prepared by a registered Professional Engineer using the actual conditions of the proposed site.
- Final wall design must address both internal and external drainage and shall be evaluated by the Professional Engineer who is responsible for the wall design.
- Block sizes and placement shown are for reference only. Individual Belvedere blocks will vary with installation pattern.

BELVEDERE RETAINING WALL INSTALLATION NOTES

1. Review all plans and specifications for the project. Make sure you understand the detailed design for the project before starting construction.
2. Leveling pad excavation should be to the depth shown in the engineered plans for the wall, but at least 6" (150 mm) below the elevation of the bottom block in the wall.
3. Leveling pad excavation width should be a minimum of 27" (690 mm), which will provide 6" (150 mm) in front of and 12" (300 mm) behind the bottom block.
4. Existing foundation soil (soil below wall) should be compacted to a minimum of 95% of standard proctor before leveling pad material is introduced. Foundation soil should be firm, dry and free of debris, stones, roots, etc. Consult a soils engineer if in doubt.
5. Place leveling pad material as specified in the wall design. Compact using a vibrator plate compactor.
6. Install a 4" (100 mm) diameter perforated drain pipe in the lowest portion of the free-draining stone, either on the bottom of the crushed stone leveling pad or immediately on top of the slow-draining road gravel leveling pad, depending on the detailed design. See *Typical Drain Placement Details* in this guide. Daylight the drain pipe at the ends and/or through the face of the wall to allow for drainage. The pipe can also outlet into a nearby drainage ditch or catch basin. Because water can flow both ways through the drain pipe, connection to an active storm sewer should only be made under the direction of a professional engineer.
7. Walls shall have the bottom course(s) buried to the depth shown on the engineered design. A minimum depth of 6" (150 mm) is required for all walls.
8. Place the bottom course of wall blocks. Take care to level the blocks both parallel and perpendicular to the wall.
9. Backfill the first 12" (300 mm) behind the blocks and triangle shaped areas between the blocks with ASTM No. 57 drainstone. Place a layer of non-woven geotextile fabric immediately behind the drainstone and then place the retained or reinforced soil.
10. Drainstone and backfill shall be placed in maximum 6" (150 mm) lifts and compacted to a minimum of 95% of standard proctor. Hand compaction with a vibratory plate compactor shall be used within 3' (1 m) of the retaining blocks. All compaction equipment shall be large enough to achieve desired compaction, but not so large as to move the wall blocks. Monitor the wall blocks for movement during compaction and rectify if required prior to proceeding.

11. Place successive units, drainstone, and compacted backfill to the desired grade/ wall height. Make sure the wall blocks are setback a minimum of 1/2" (13 mm) for every 6" (150 mm) of wall height.
12. The top of wall must be graded to direct surface water away from the wall.
13. Coping layer should be adhered with a concrete adhesive.

ADDITIONAL REQUIREMENTS FOR GEOGRID INSTALLATION (If Required)

14. Geogrid layers shall be installed to the lengths and elevations detailed in the wall design.
15. Geogrid shall be placed starting at the face of the retaining block and extending into the reinforced soil. Take care to install the geogrid with the strong direction (roll direction) into the reinforced soil zone and not parallel to the wall.
16. Use the next layer of blocks to secure the front end of the geogrid. Make sure the geogrid is as close as possible to the front face of the wall without being visible. Pull the geogrid taut to eliminate any folds and pretension the geogrid. Pin or secure the back edge of the geogrid before placing the reinforced fill.
17. Place and compact drainstone and reinforced fill starting at the back of the blocks and continuing back into the retained soil. Drainstone and reinforced fill shall be placed in maximum 6" (150 mm) thick layers and compacted to 95% of standard proctor. Hand compaction with a vibratory plate shall be used within 3 feet (1 m) of the retaining wall blocks. All compaction equipment shall be large enough to achieve desired compaction, but not so large as to move the wall blocks. Monitor the wall blocks for movement during compaction and rectify if required prior to proceeding.
18. Tracked construction equipment shall not be used directly on the geogrid. A minimum of 6" (150 mm) of fill is required between tracked equipment and geogrid to prevent damage to the grid. Rubber-tired equipment may pass over the geogrid when traveling at low speeds of 5 mph (8 km/h) or less.
19. Avoid any sudden stopping or turning of construction equipment in the reinforced fill zone to prevent moving or damaging the geogrid layers.
20. Follow geogrid manufacturer's requirements, including requirements for vertical separation and overlap of geogrid.

***Rosetta Hardscapes, LLC products are not intended for direct exposure to intense heat or open flame. Exploding concrete may cause severe bodily injury and/or property damage.**

WALL PATTERNS - RETAINING

Belvedere Collection blocks are provided in six sizes. This gives you the flexibility to arrange the blocks in various configurations and create a custom look for your project. Here are some sample patterns to help you get started. These base patterns can be fit together in multiple ways to make walls of varying heights and lengths. Try these patterns and feel free to experiment with your own.

Notation: The blocks shown below are labeled to be consistent with the convention used throughout this guide. For example, 4F would indicate the front (or longer) face of block 4, and 2B would indicate the back (or shorter) face of block 2.

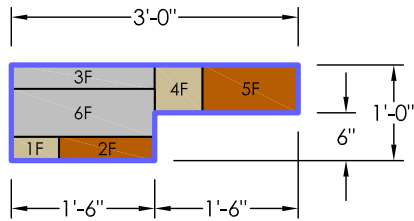

12" Top Left End

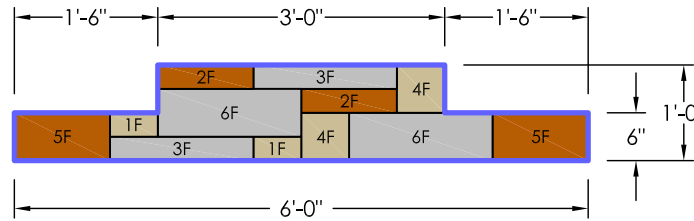

12" Pattern

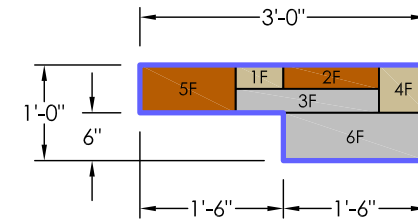

12" Top Right End

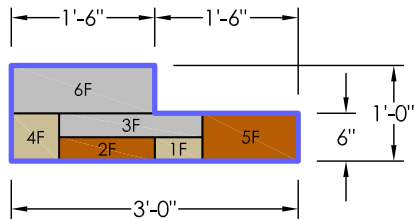

12" Bottom Left End

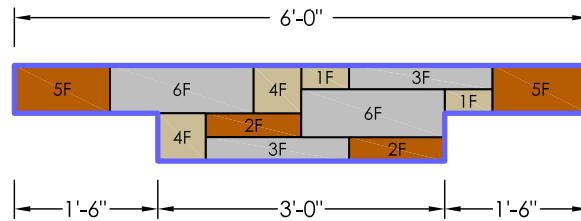

12" Pattern - Upside Down

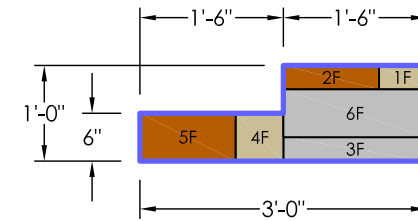

12" Bottom Right End

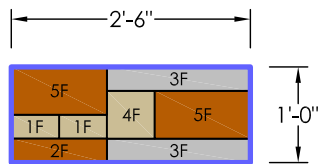

Corner Filler Pattern 1

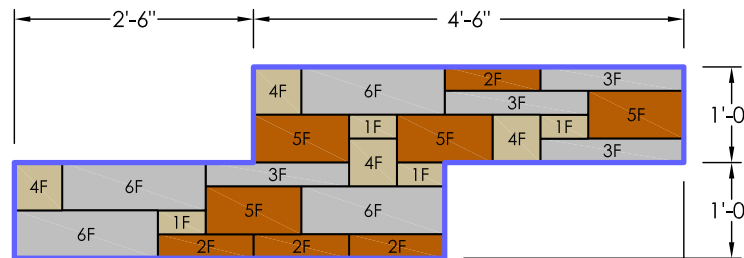

24" Pattern

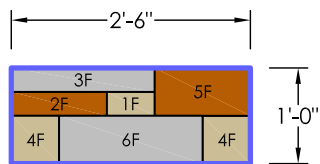

Corner Filler Pattern 2

NOTE: Retaining walls are typically constructed with the front face of the block exposed. The v-shaped notches which appear on the back of wall between adjacent blocks must be filled with drainstone.

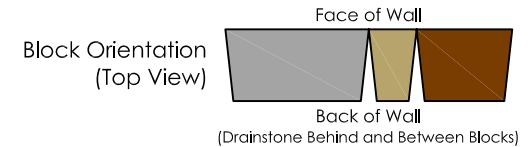

NOTE: These patterns are NOT required and are presented for reference only. They are most useful for long, straight sections of retaining walls.

WALL PATTERNS - RETAINING (CONTINUED)

This page shows wall layouts created from combining different sample patterns. These are examples only and are presented as aides for construction. You are welcome to adjust block placement as desired and not required to follow these layouts.

Notation: The blocks shown below are labeled to be consistent with the convention used throughout this guide. For example, 4F would indicate the front (or longer) face of block 4, and 2B would indicate the back (or shorter) face of block 2.

12" High Wall

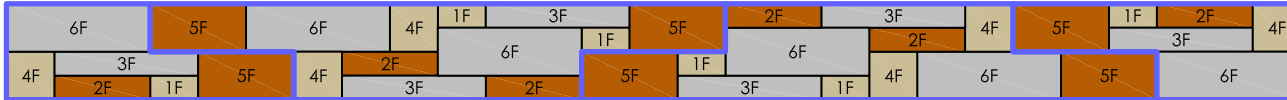

12" High x 13'-6" Wall Section Shown = 13.5 sft (1/2 Wall Pallet)

18" High Wall

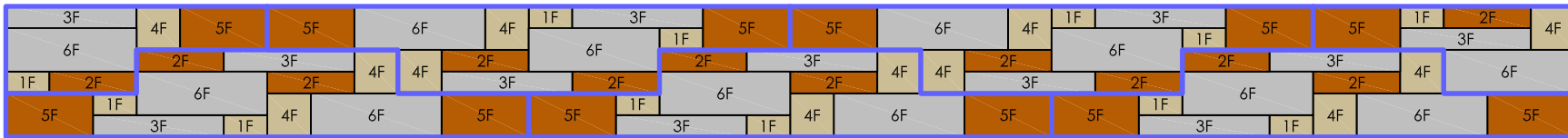

18" High x 18'-0" Wall Section Shown = 27.0 sft (1 Wall Pallet)

24" High Wall

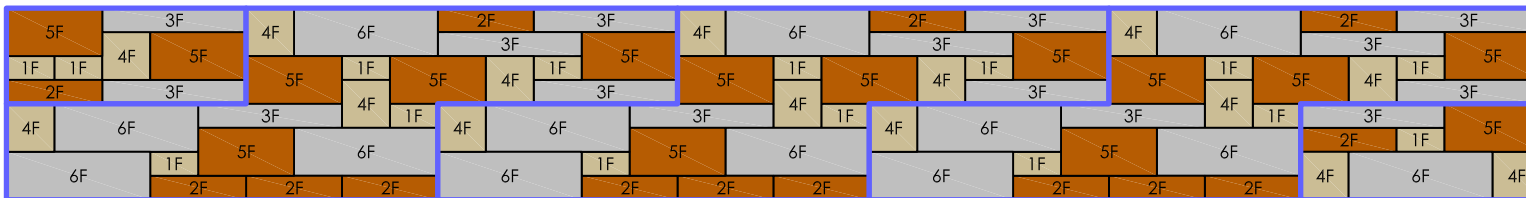

24" High x 16'-0" Wall Section Shown = 32.0 sft (Approx. 1.2 Wall Pallets)

TYPICAL FREESTANDING WALL CONSTRUCTION DETAILS

This page shows typical construction details for Belvedere freestanding walls. These drawings are representative of major components required in wall construction. Belvedere freestanding walls are intended to be low walls (24" or lower) used in a garden or patio setting. Taller walls, walls intended to act as railings or barriers, walls constructed in other settings, or walls subject to applied loads will require project specific engineering.

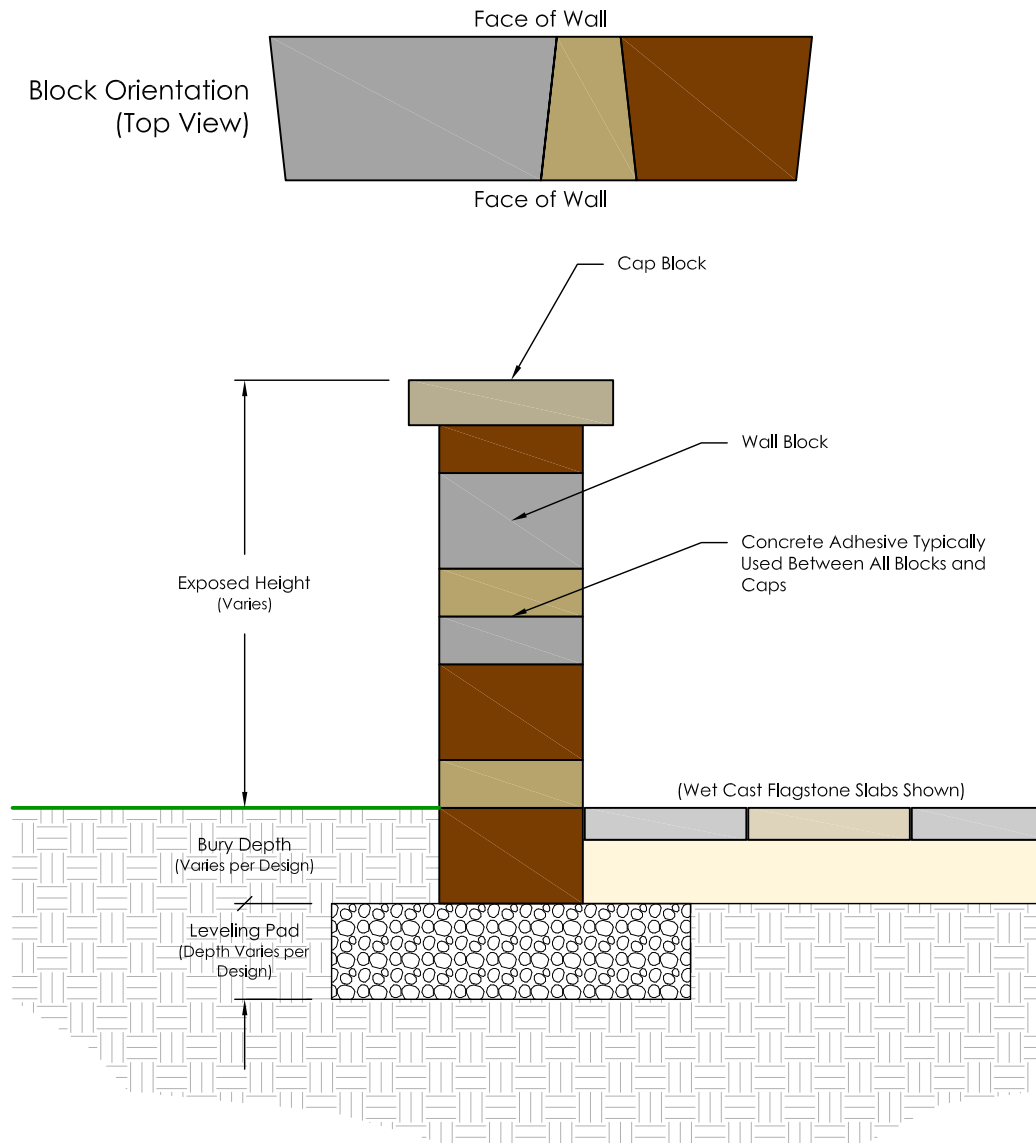

Belvedere Freestanding Installation Notes

1. Leveling pad excavation should be to the depth shown in the engineered plans for the wall, but at least 6" (150 mm) below the elevation of the bottom block in the wall.
2. Leveling pad excavation width should be a minimum of 21" (530 mm), which will provide 6" (150 mm) in front of and behind the bottom block.
3. Existing foundation soil should be compacted to a minimum of 95% of standard proctor before leveling pad material is introduced. Foundation soil should be firm, dry and free of debris, stones, roots, etc. Consult a soils engineer if soil stability is in doubt.
4. Place crushed stone or well-graded road gravel leveling pad material as specified in the wall design. Compact using a vibrator plate compactor.
5. Walls shall have the bottom course buried to the depth shown on the engineered design. Typically, walls are buried 4" to 6" (100 mm to 150 mm).
6. Place the bottom course of wall blocks. Take care to level the blocks both parallel and perpendicular to the wall. Adjacent blocks should be placed so the tapers on the sides are going opposite directions to provide a uniform wall face with no gaps on either side of the wall.
7. Place successive units to the desired wall height.
8. Typically, concrete adhesive is used between all blocks and the coping layer to help provide additional stability of the blocks.

· This drawing is for reference only.
 · Final designs for construction for walls subject to any loading must be prepared by a registered Professional Engineer.
 · Block sizes and placement shown are for reference only. Individual Belvedere blocks will vary with installation pattern.

WALL PATTERNS - FREESTANDING

Belvedere Collection blocks are finished on front and back faces and tapered on both sides. When the blocks are installed with alternating front face and back faces of the blocks on the same side of the wall, the blocks fit tight together providing a continuous freestanding wall which has face textures on both sides. This page shows some sample patterns which can be fit together to make walls of varying heights and lengths. These are examples only and are presented as aides for construction. You are welcome to adjust block placement as desired and not required to follow these layouts.

Notation: The blocks shown below are labeled to be consistent with the convention used throughout this guide. For example, 4F would indicate the front (or longer) face of block 4, and 2B would indicate the back (or shorter) face of block 2.

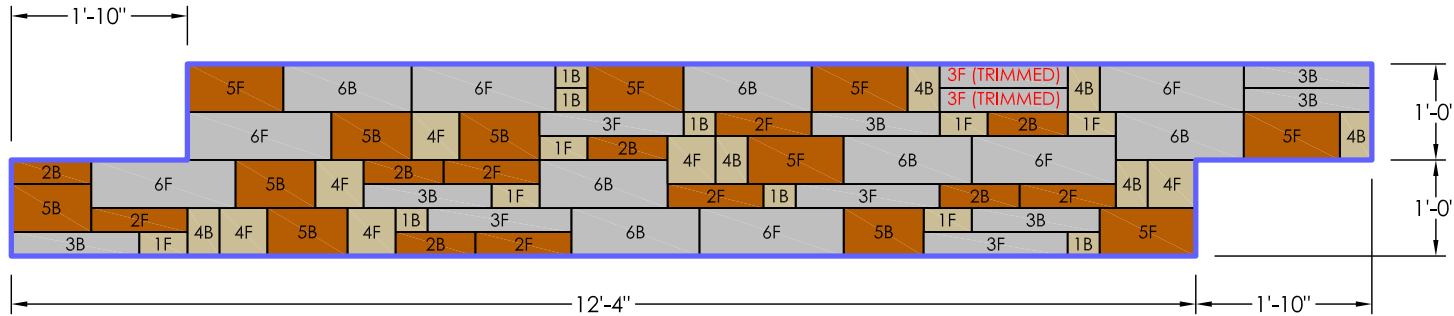

24" Pattern A
 Wall Section Shown = 24.67 sft
 (1 Wall Pallet)
 Note: 2" must be trimmed from (2) 3" blocks to make this pattern

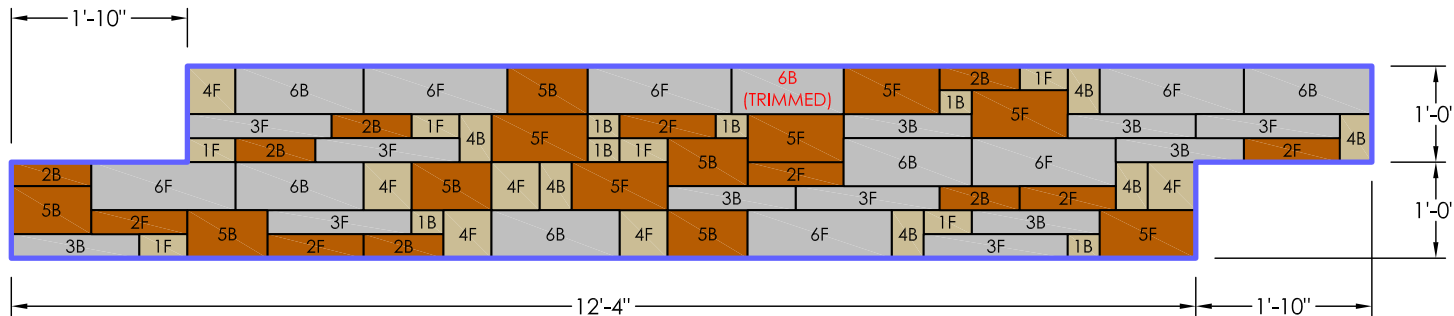

24" Pattern B
 Wall Section Shown = 24.67 sft
 (1 Wall Pallet)
 Note: 2" must be trimmed from (1) 6" block to make this pattern

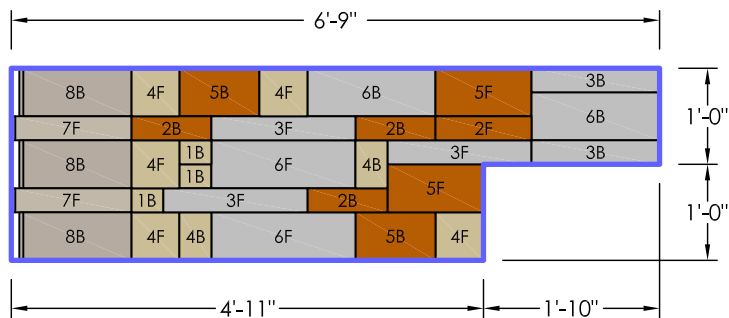

24" High Vertical End - Left
 Wall Section Shown = 11.67 sft (Approx. 1/2 Wall Pallet)
 Note: Vertical End jogs in and out approximately 1" between blocks

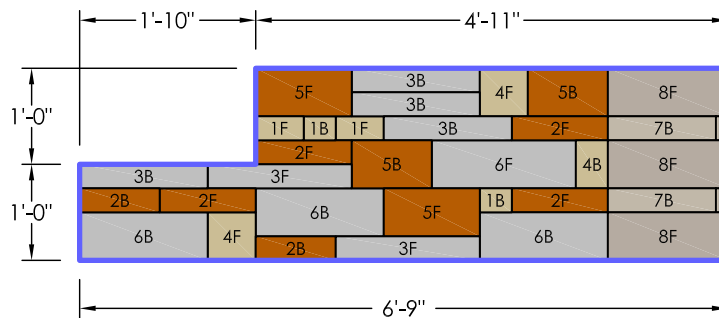

24" High Vertical End - Right
 Wall Section Shown = 11.67 sft (Approx. 1/2 Wall Pallet)
 Note: Vertical End jogs in and out approximately 1" between blocks

NOTE: These patterns are NOT required and are presented for reference only. They are most useful for long, straight sections of freestanding walls. Blocks can also be fit together on-site with select blocks trimmed as necessary to complete your wall.

PILLAR CONSTRUCTION DETAILS

This page shows typical construction details for Belvedere pillars. Pillars make nice ends to freestanding walls, formal stair openings, stand-alone monuments, and other areas to enhance your Belvedere project. The basic steps of pillar construction are shown here. Feel free to expand on these ideas and bring your own creativity into creating a custom project.

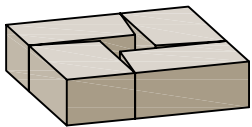

Step 1

Place (4) 3" or 6" high corner blocks with the taper facing into the center of the pillar.

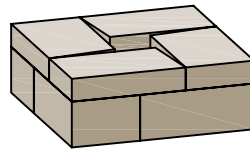

Step 2

Place the second row of (4) of the corner blocks with the taper facing into the center of the pillar. Typically if the first row is built with 6" corner blocks, the second row is built with 3" corner blocks.

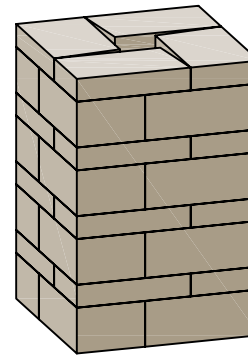

Step 3

Continue with subsequent rows to the desired pillar height. One pallet of corner blocks will make a 24" x 24" x 36" high column.

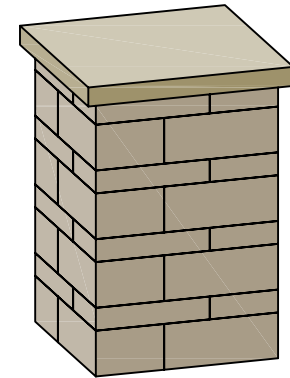

Step 4

Place a column cap to finish the pillar. The column cap can be cored as needed for installation of a light.

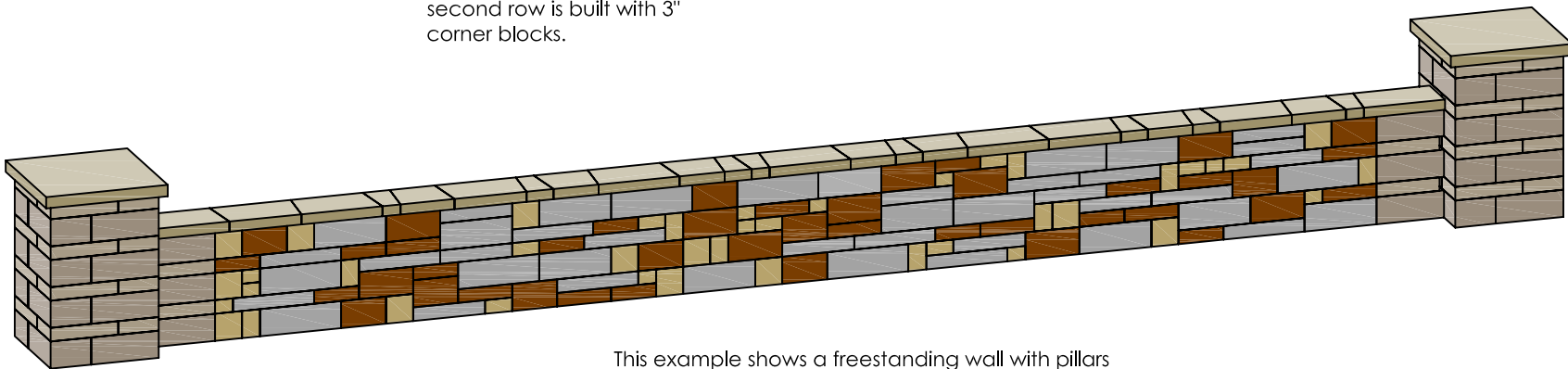

This example shows a freestanding wall with pillars on each end. The wall can either be constructed flush with the pillars, or blocks trimmed to interlock the end of the wall with the pillar.

INSIDE STEPS

This page shows typical construction details for making stair openings into a wall using Belvedere blocks and Rosetta dimensional steps. Stairs are a focal point in any project and need to be constructed properly. With some advance planning, installation can be easy and look great.

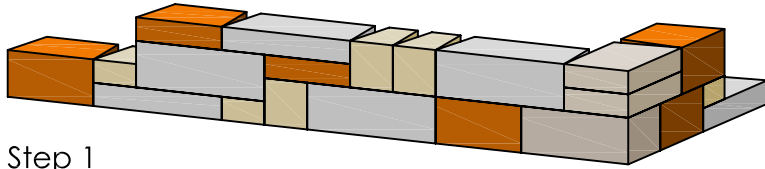

Step 1

Start construction of the first corner, working out in both directions.

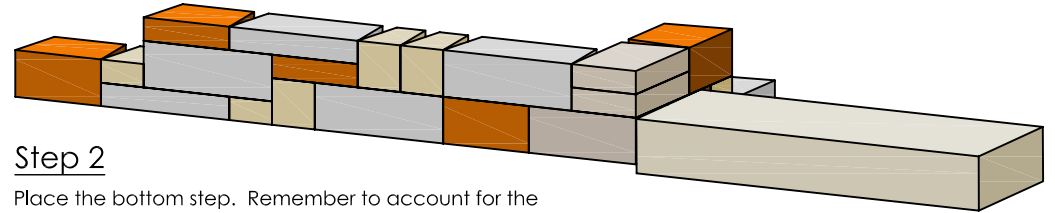

Step 2

Place the bottom step. Remember to account for the total rise of all steps and final cap elevations when setting the grade for the bottom step. Also remember to place the steps at a 1% - 2% grade to allow surface water drainage and avoid ponding on the steps.

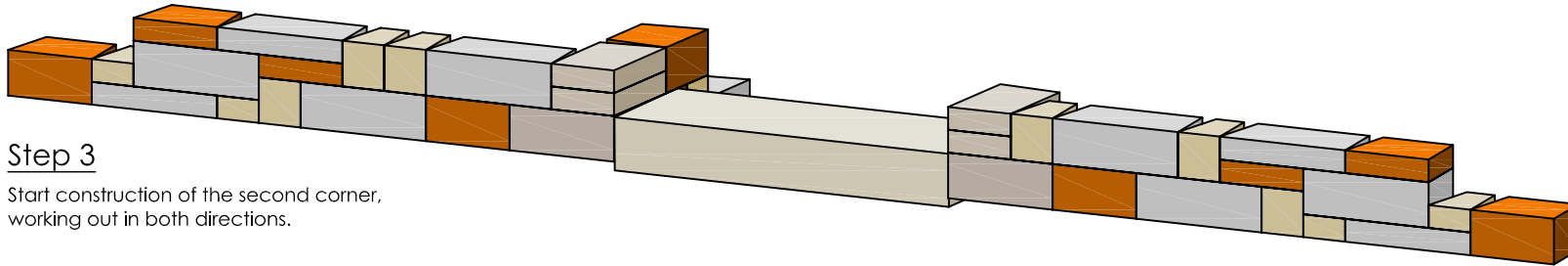

Step 3

Start construction of the second corner, working out in both directions.

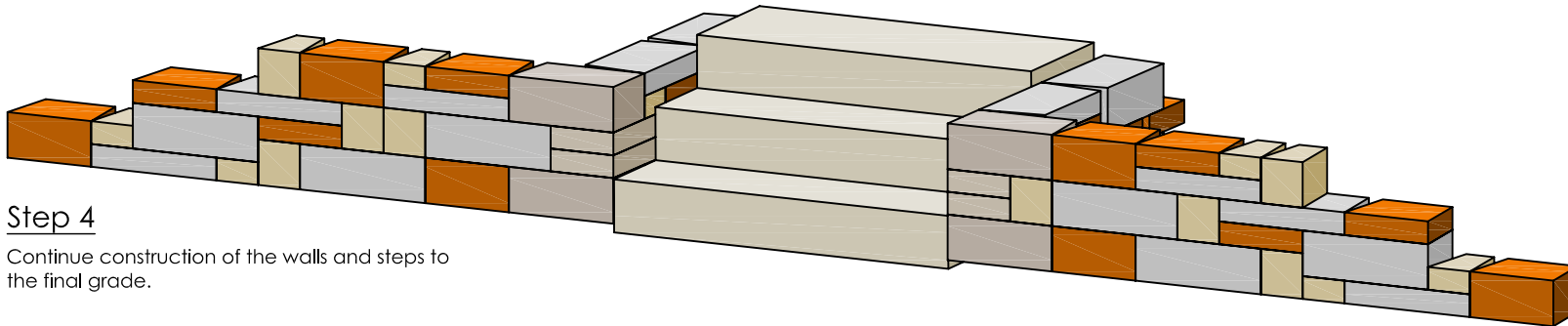

Step 4

Continue construction of the walls and steps to the final grade.

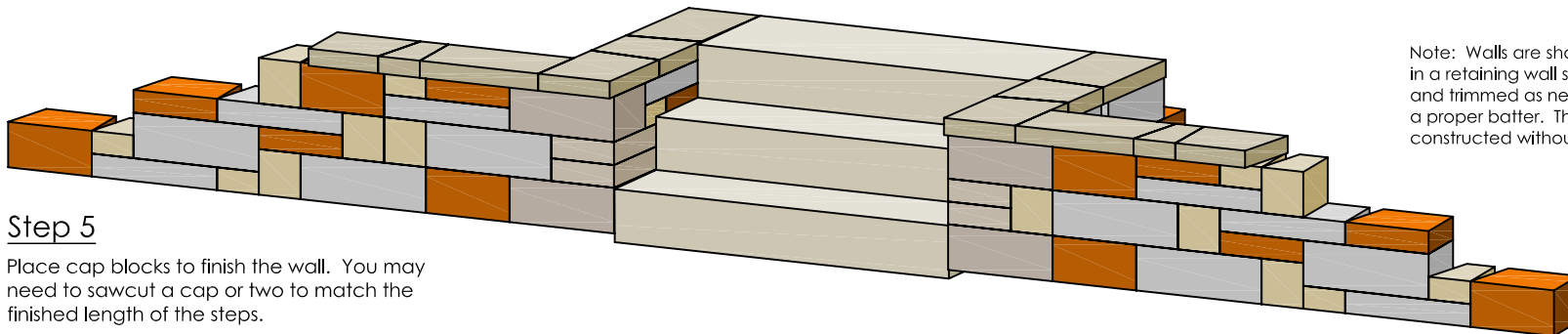

Step 5

Place cap blocks to finish the wall. You may need to sawcut a cap or two to match the finished length of the steps.

Note: Walls are shown without batter for clarity. Blocks in a retaining wall should be adjusted slightly in place and trimmed as needed to allow wall construction with a proper batter. The inside wingwalls are typically constructed without batter to match the steps.

CORNER DETAILS

This page shows typical construction details for making 90° corners with Belvedere blocks. Some basic concepts are shown here. Plan to take some time to properly work corners into the larger retaining and freestanding wall patterns.

OUTSIDE CORNER

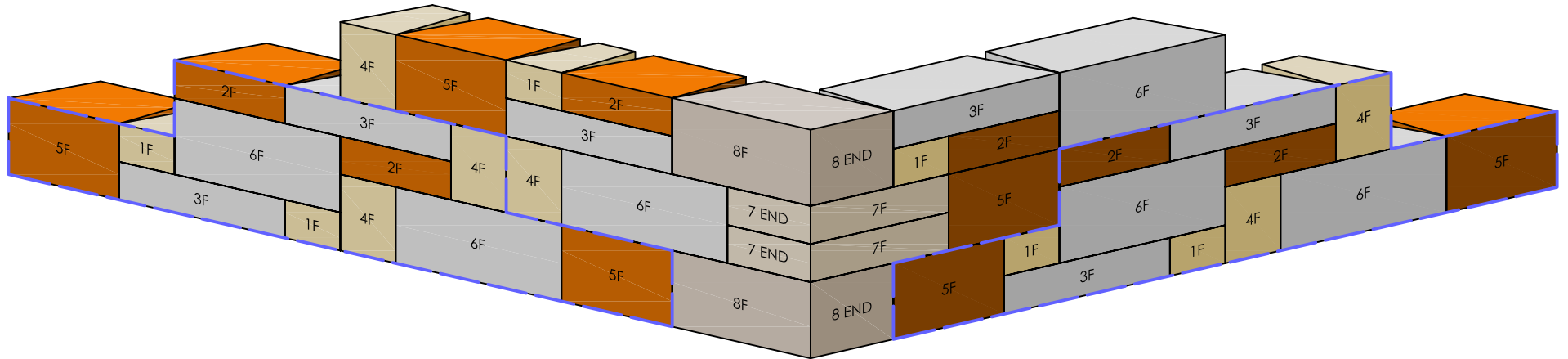

INSIDE CORNER

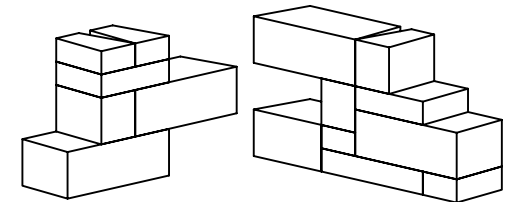
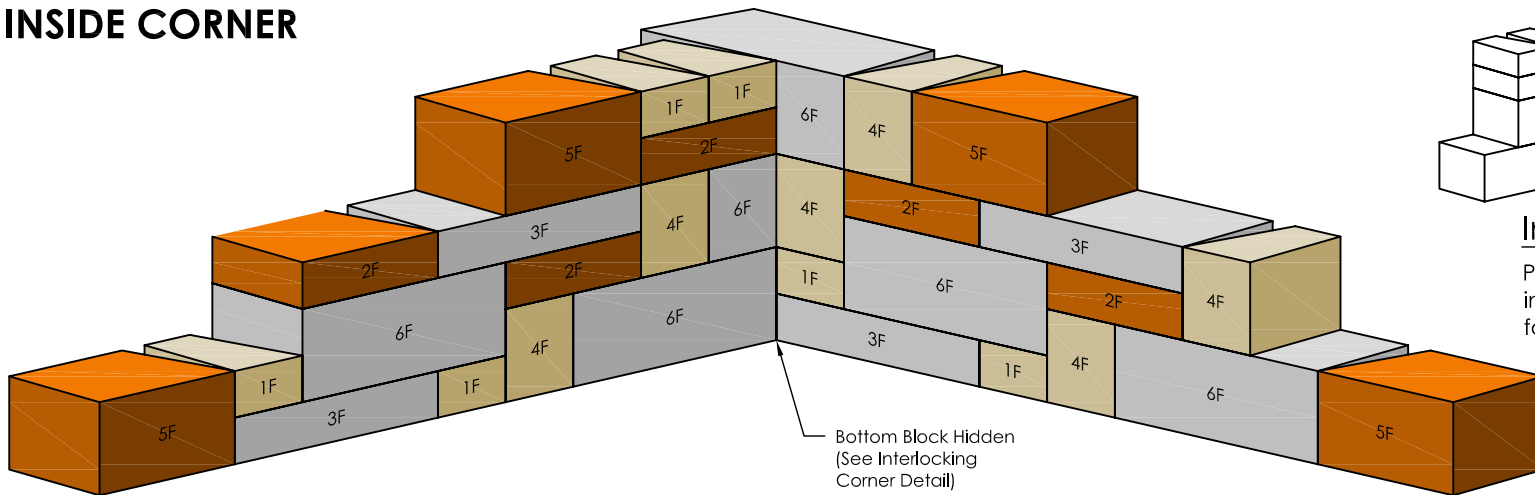

Interlocking Corner

Place blocks in an overlapping, interlocking pattern at corner for added wall stability.

Note: Walls are shown without batter for clarity. Blocks in a retaining wall should be adjusted slightly in place and trimmed as needed to allow wall construction with a proper batter.

CURVED WALLS

This page shows typical construction details for making curved retaining walls with Belvedere blocks. The taper on the sides of the blocks allow for construction of a wide range of curves in both retaining and freestanding walls.

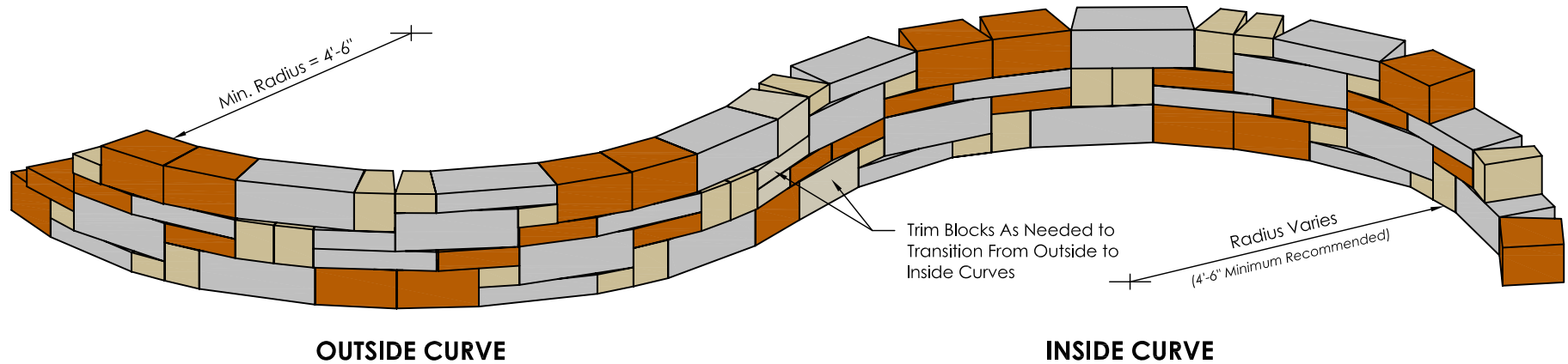

Notes:

1. These details show curved retaining walls.
2. Minimum radius curves are shown which can be constructed without sawcutting a significant number of blocks. Larger radius curves can be created by leaving a larger gap between blocks on the back side of the wall. The gaps must be filled with drainstone.
3. When retaining walls are constructed with a batter, the radius on outside curves becomes smaller with each course due to the block setback. For proper construction, the radius of the bottom course must be larger than the minimum radius so upper courses will have sufficient room for construction.
4. When retaining walls are constructed with a batter, the radius on inside curves becomes larger with each course due to the block setback.

Curved Freestanding Walls:

Curved freestanding walls can also be built. Typically, the blocks have to be field adjusted to make the desired curve. Front and back faces will alternate and blocks trimmed as needed to provide a tight fit between blocks with no gaps on either side of the freestanding wall.

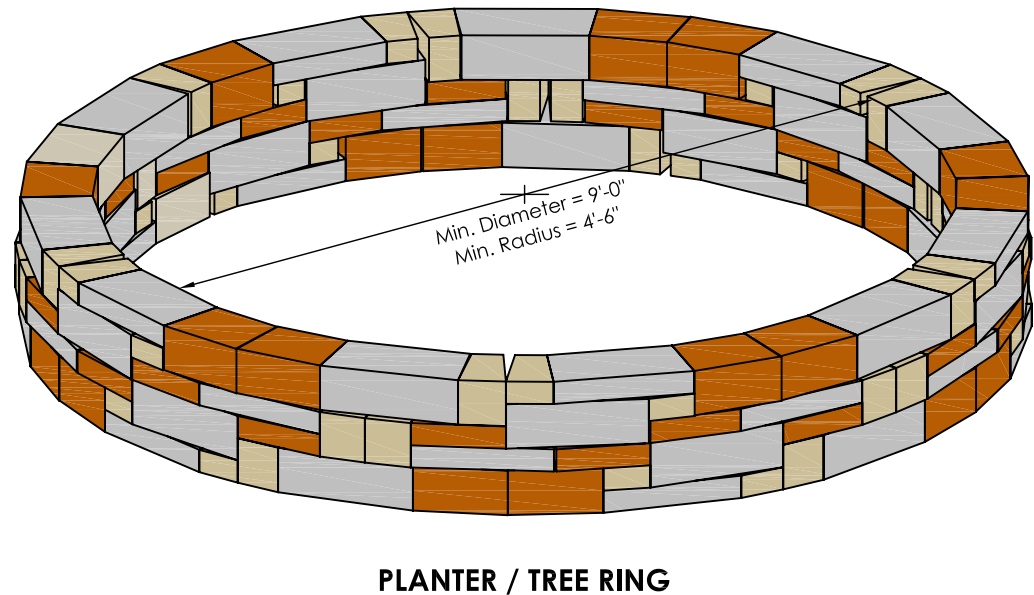

Note: Walls are shown without batter for clarity. Blocks in a retaining wall should be adjusted slightly in place and trimmed as needed to allow wall construction with a proper batter.

PRELIMINARY WALL HEIGHT GUIDES

This page shows preliminary guides for soil reinforcement required to construct a wall with Belvedere Collection blocks in the conditions noted below. The geogrid reinforcement is Mirafi Miragrid 2XT. The geogrid layers shall be placed with 100% coverage along the length of the wall (no gaps between sections of grid). See wall installation details for typical construction notes. As always, follow the specific requirements shown in the engineered design for your wall.

SILTY SAND or CLAYEY SAND ($\phi = 28^\circ$, $\gamma = 120$ pcf) NO BACKSLOPE NO SURCHARGE

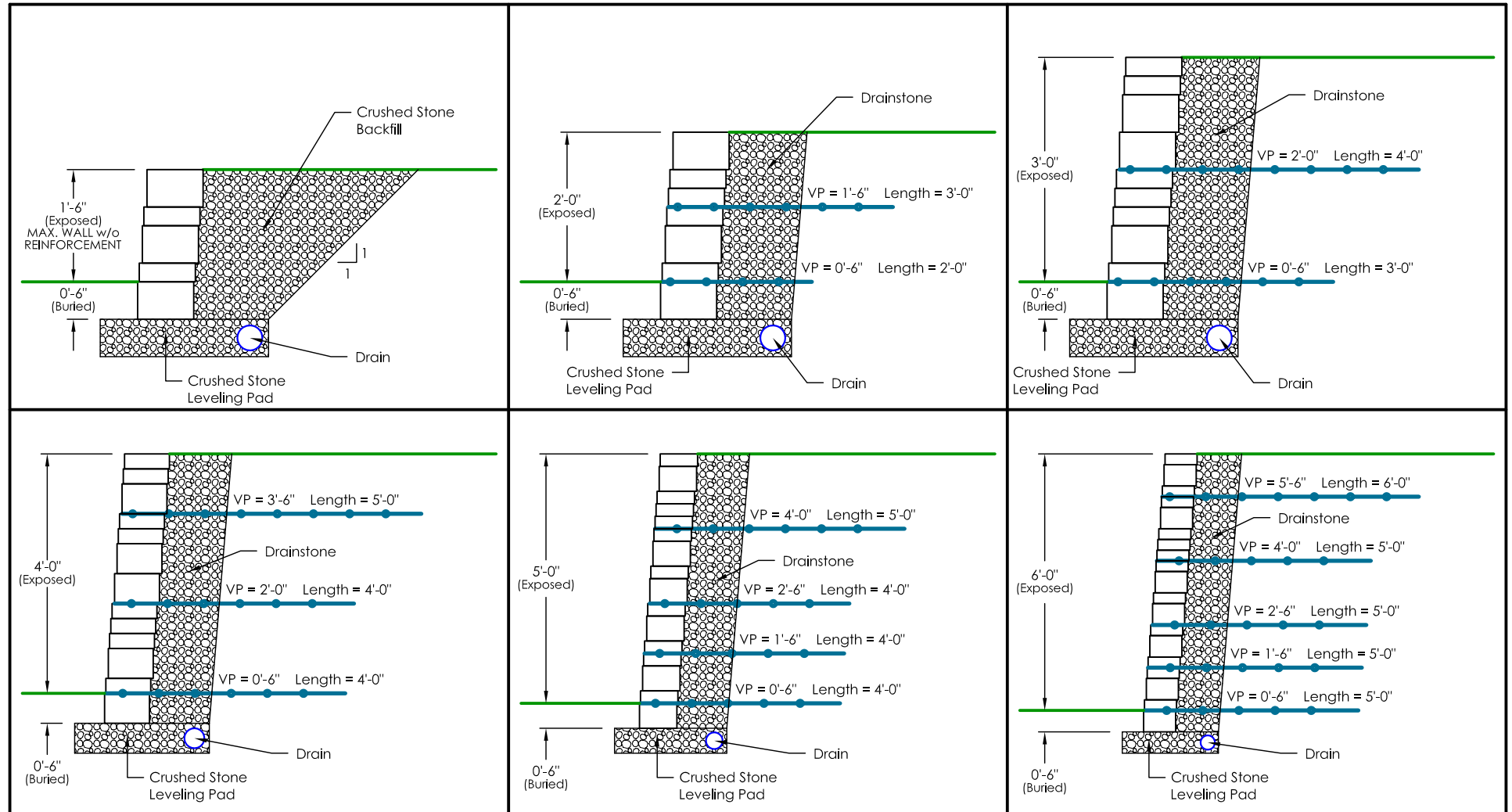

- These drawings are for reference only.
- Final designs for construction must be prepared by a registered professional engineer, using the actual conditions of the proposed site. Wall stability must be verified for site specific conditions.
- Final wall design must address both internal and external drainage and shall be evaluated by the professional engineer who is responsible for the wall design.
- Seismic conditions are not included in these guides and must be analyzed based on site specific conditions.
- Vertical placement (VP) of geogrid is measured up from the bottom of the blocks/top of the stone leveling pad.
- Length of geogrid is measured from the front of the Belvedere blocks.

- These guides assume a flat "toe" slope at the bottom of the wall. Toe slopes must be analyzed based on site conditions.
- Minimum Factors of Safety for the assumed conditions shown above are 1.5 for sliding, 2.0 for overturning, and 2.0 for bearing capacity.
- Designs are in general accordance with NCMA's *Design Manual for Segmental Retaining Walls, 2nd Ed.*
- Reinforced and Backfill soils are to be compacted to 95% maximum dry density (Standard Proctor).
- All Belvedere Specifications are to be followed.
- Block sizes and placement shown are for reference only. Individual Belvedere Collection blocks will vary with installation pattern.

PRELIMINARY WALL HEIGHT GUIDES

This page shows preliminary guides for soil reinforcement required to construct a wall with Belvedere Collection blocks in the conditions noted below. The geogrid reinforcement is Mirafi Miragrid 2XT. The geogrid layers shall be placed with 100% coverage along the length of the wall (no gaps between sections of grid). See wall installation details for typical construction notes. As always, follow the specific requirements shown in the engineered design for your wall.

SILTY SAND or CLAYEY SAND ($\phi = 28^\circ$, $\gamma = 120$ pcf) NO BACKSLOPE LIGHT TRAFFIC SURCHARGE (NO TRUCKS) (100 PSF)

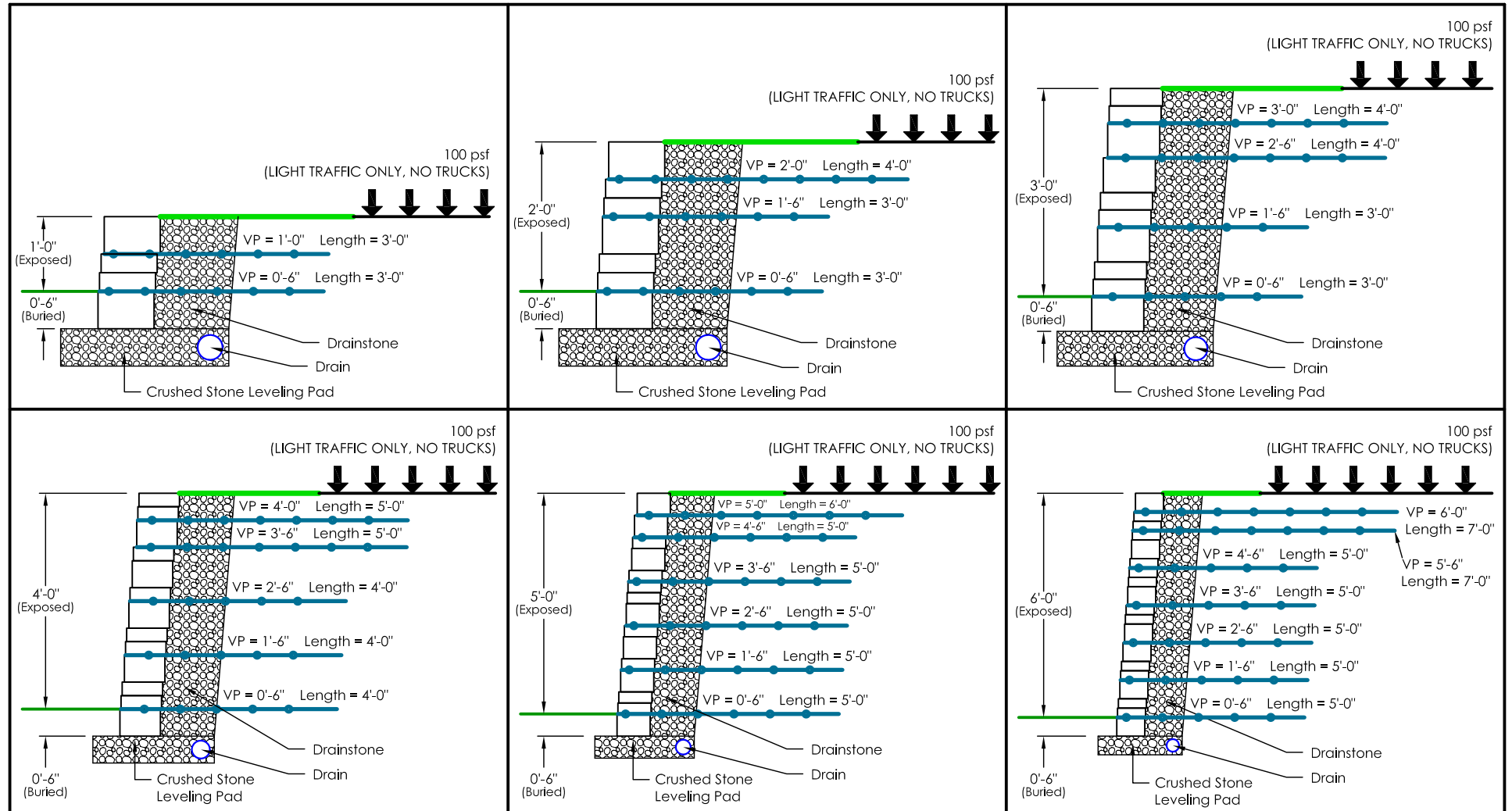

- These drawings are for reference only.
- Final designs for construction must be prepared by a registered professional engineer using the actual conditions of the proposed site. Wall stability must be verified for site specific conditions.
- Final wall design must address both internal and external drainage and shall be evaluated by the professional engineer who is responsible for the wall design.
- Seismic conditions are not included in these guides and must be analyzed based on site specific conditions.
- Vertical placement (VP) of geogrid is measured up from the bottom of the blocks/top of the stone leveling pad.
- Length of geogrid is measured from the front of the Belvedere blocks.

- These guides assume a flat "toe" slope at the bottom of the wall. Toe slopes must be analyzed based on site conditions.
- Minimum Factors of Safety for the assumed conditions shown above are 1.5 for sliding, 2.0 for overturning, and 2.0 for bearing capacity.
- Designs are in general accordance with NCMA's *Design Manual for Segmental Retaining Walls, 2nd Ed.*
- Reinforced and Backfill soils are to be compacted to 95% maximum dry density (Standard Proctor).
- All Belvedere Specifications are to be followed.
- Block sizes and placement shown are for reference only. Individual Belvedere Collection blocks will vary with installation pattern.

PRELIMINARY WALL HEIGHT GUIDES

This page shows preliminary guides for soil reinforcement required to construct a wall with Belvedere Collection blocks in the conditions noted below. The geogrid reinforcement is Mirafi Miragrid 2XT. The geogrid layers shall be placed with 100% coverage along the length of the wall (no gaps between sections of grid). See wall installation details for typical construction notes. As always, follow the specific requirements shown in the engineered design for your wall.

SILTY SAND or CLAYEY SAND ($\phi = 28^\circ, \gamma = 120$ pcf) 1 on 3 (18.5°) BACKSLOPE

NO SURCHARGE

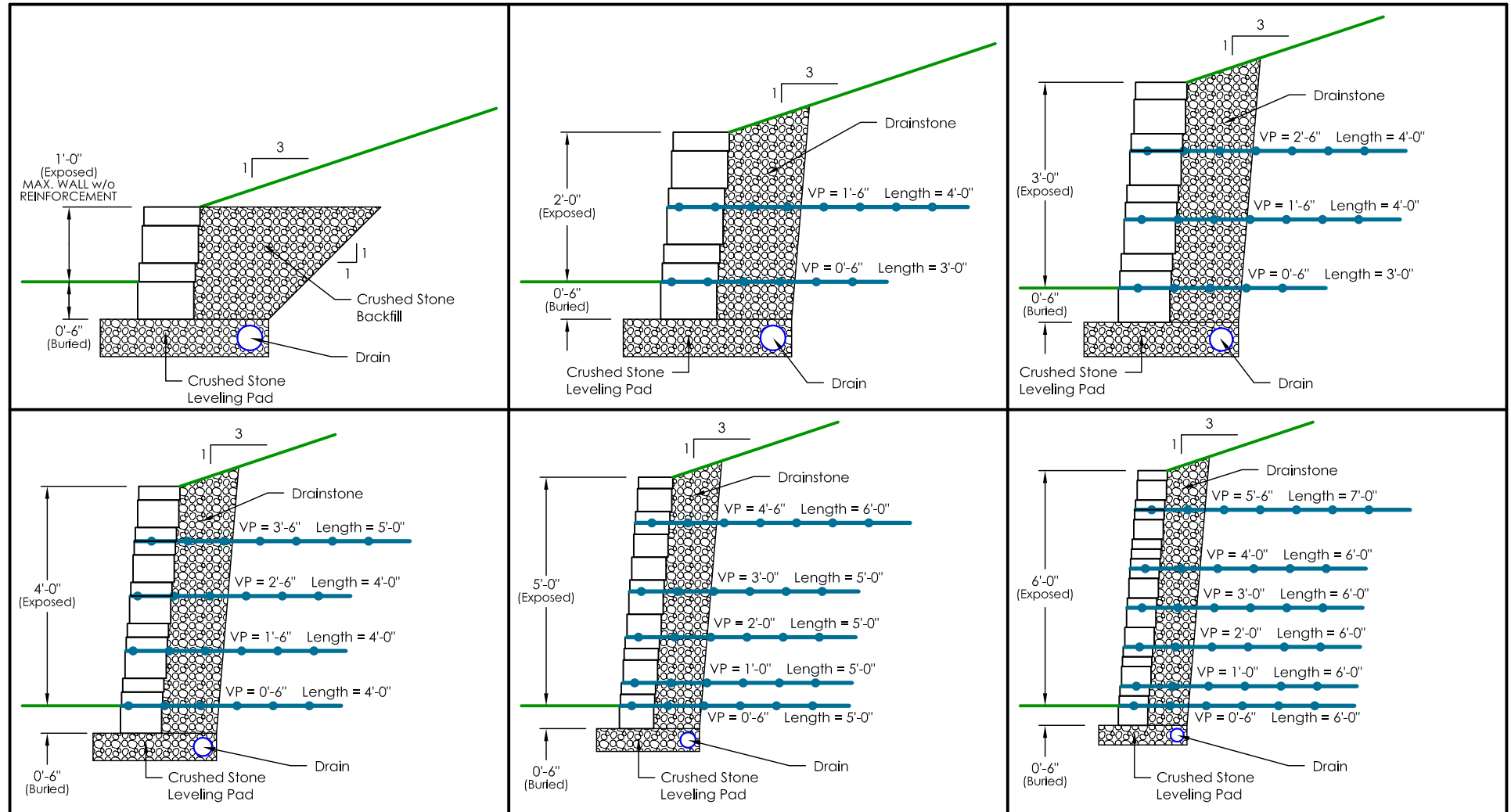

- These drawings are for reference only.
- Final designs for construction must be prepared by a registered professional engineer, using the actual conditions of the proposed site. Wall stability must be verified for site specific conditions.
- Final wall design must address both internal and external drainage and shall be evaluated by the professional engineer who is responsible for the wall design.
- Seismic conditions are not included in these guides and must be analyzed based on site specific conditions.
- Vertical placement (VP) of geogrid is measured up from the bottom of the blocks/top of the stone leveling pad.
- Length of geogrid is measured from the front of the Belvedere blocks.

- These guides assume a flat "toe" slope at the bottom of the wall. Toe slopes must be analyzed based on site conditions.
- Minimum Factors of Safety for the assumed conditions shown above are 1.5 for sliding, 2.0 for overturning, and 2.0 for bearing capacity.
- Designs are in general accordance with NCMA's *Design Manual for Segmental Retaining Walls, 2nd Ed.*
- Reinforced and Backfill soils are to be compacted to 95% maximum dry density (Standard Proctor).
- All Belvedere Specifications are to be followed.
- Block sizes and placement shown are for reference only. Individual Belvedere Collection blocks will vary with installation pattern.

PRELIMINARY WALL HEIGHT GUIDES

This page shows preliminary guides for soil reinforcement required to construct a wall with Belvedere Collection blocks in the conditions noted below. The geogrid reinforcement is Mirafi Miragrid 2XT. The geogrid layers shall be placed with 100% coverage along the length of the wall (no gaps between sections of grid). See wall installation details for typical construction notes. As always, follow the specific requirements shown in the engineered design for your wall.

FINE TO MEDIUM SAND ($\phi = 30^\circ$, $\gamma = 120$ pcf) **NO BACKSLOPE** **NO SURCHARGE**

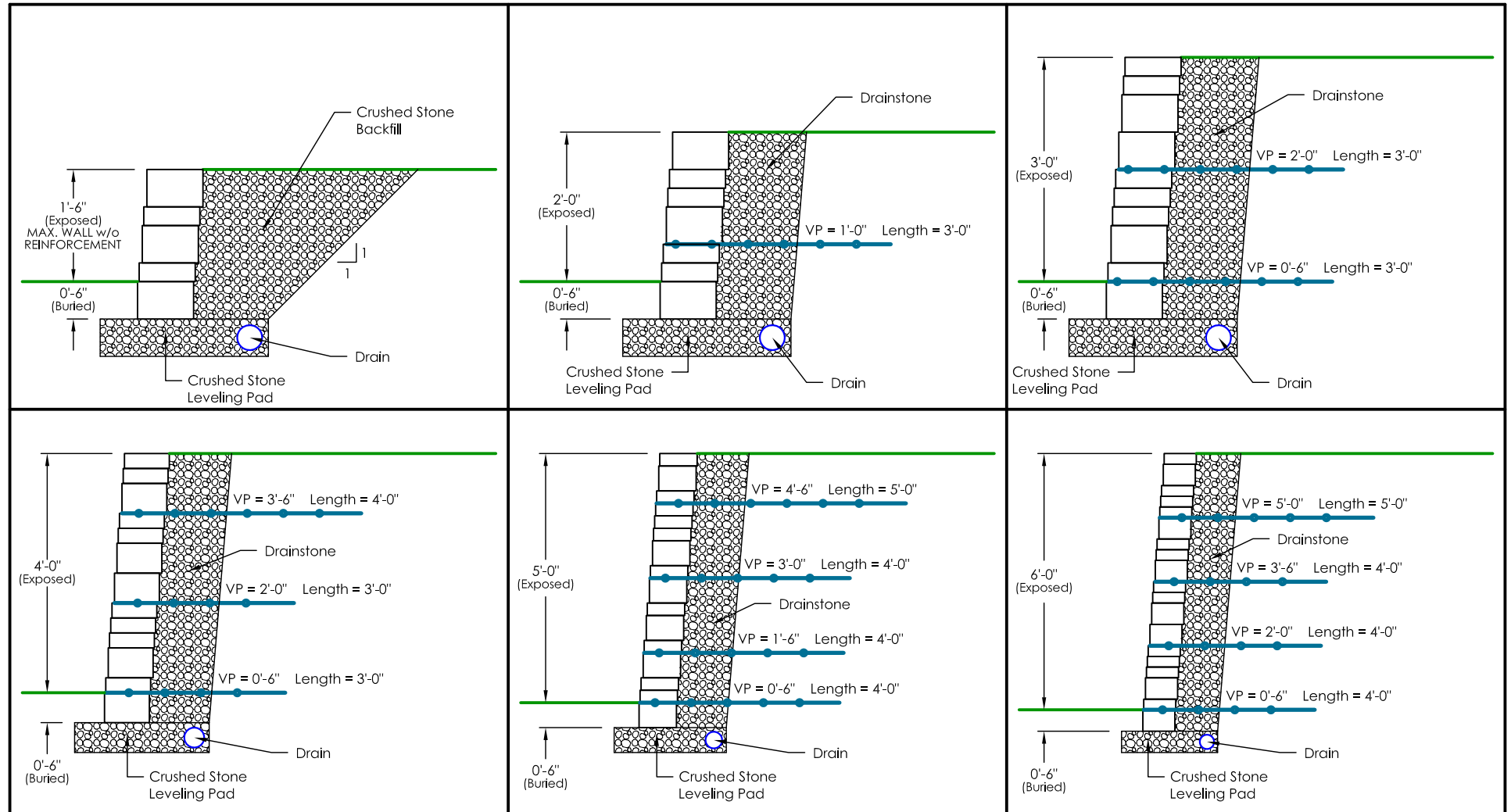

- These drawings are for reference only.
- Final designs for construction must be prepared by a registered professional engineer, using the actual conditions of the proposed site. Wall stability must be verified for site specific conditions.
- Final wall design must address both internal and external drainage and shall be evaluated by the professional engineer who is responsible for the wall design.
- Seismic conditions are not included in these guides and must be analyzed based on site specific conditions.
- Vertical placement (VP) of geogrid is measured up from the bottom of the blocks/top of the stone leveling pad.
- Length of geogrid is measured from the front of the Belvedere blocks.

- These guides assume a flat "toe" slope at the bottom of the wall. Toe slopes must be analyzed based on site conditions.
- Minimum Factors of Safety for the assumed conditions shown above are 1.5 for sliding, 2.0 for overturning, and 2.0 for bearing capacity.
- Designs are in general accordance with NCMA's *Design Manual for Segmental Retaining Walls, 2nd Ed.*
- Reinforced and Backfill soils are to be compacted to 95% maximum dry density (Standard Proctor).
- All Belvedere Specifications are to be followed.
- Block sizes and placement shown are for reference only. Individual Belvedere Collection blocks will vary with installation pattern.

PRELIMINARY WALL HEIGHT GUIDES

This page shows preliminary guides for soil reinforcement required to construct a wall with Belvedere Collection blocks in the conditions noted below. The geogrid reinforcement is Mirafi Miragrid 2XT. The geogrid layers shall be placed with 100% coverage along the length of the wall (no gaps between sections of grid). See wall installation details for typical construction notes. As always, follow the specific requirements shown in the engineered design for your wall.

FINE TO MEDIUM SAND ($\phi = 30^\circ$, $\gamma = 120$ pcf) **NO BACKSLOPE** **LIGHT TRAFFIC SURCHARGE (NO TRUCKS) (100 PSF)**

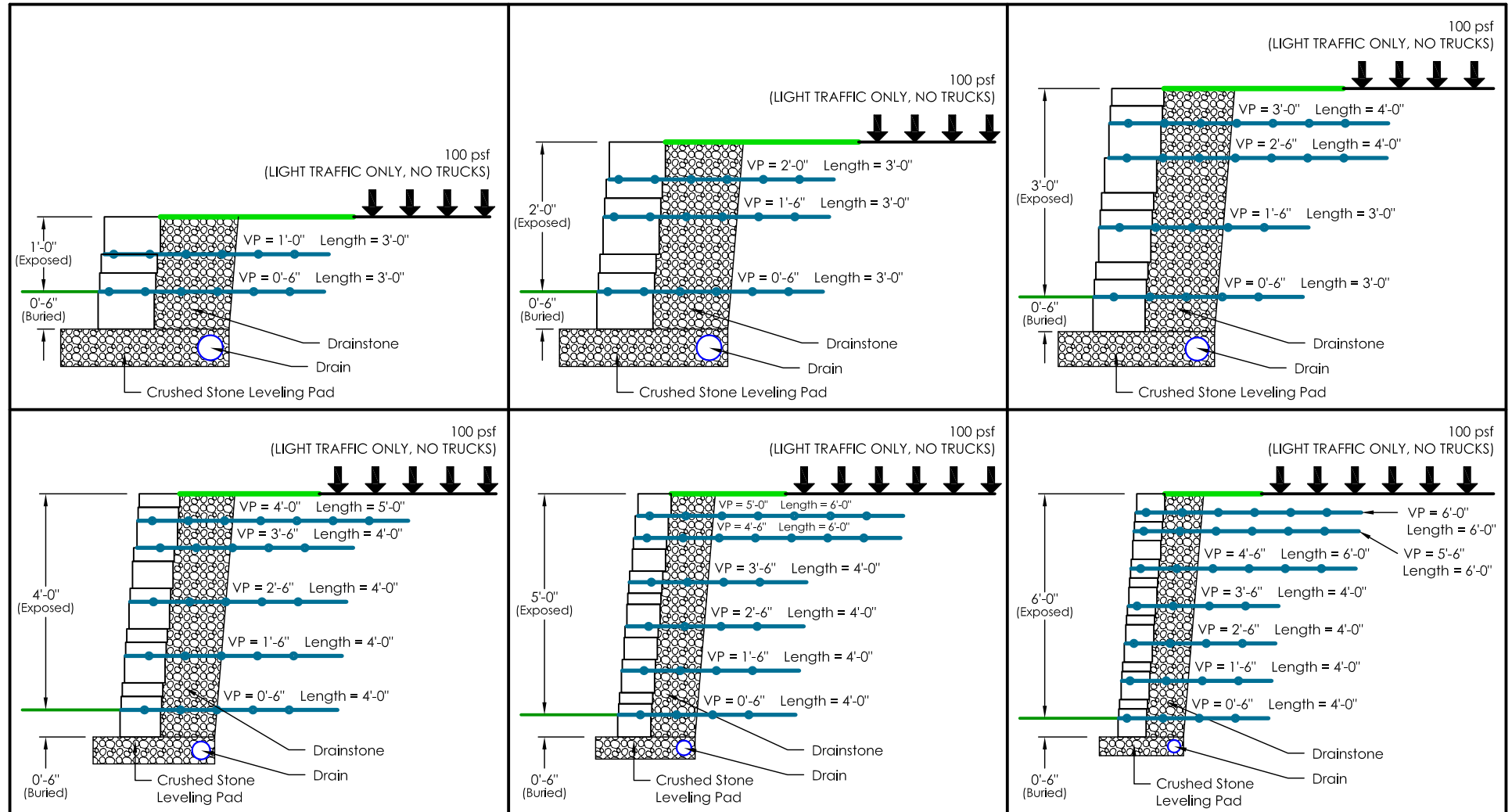

- These drawings are for reference only.
- Final designs for construction must be prepared by a registered professional engineer, using the actual conditions of the proposed site. Wall stability must be verified for site specific conditions.
- Final wall design must address both internal and external drainage and shall be evaluated by the professional engineer who is responsible for the wall design.
- Seismic conditions are not included in these guides and must be analyzed based on site specific conditions.
- Vertical placement (VP) of geogrid is measured up from the bottom of the blocks/top of the stone leveling pad.
- Length of geogrid is measured from the front of the Belvedere blocks.

- These guides assume a flat "toe" slope at the bottom of the wall. Toe slopes must be analyzed based on site conditions.
- Minimum Factors of Safety for the assumed conditions shown above are 1.5 for sliding, 2.0 for overturning, and 2.0 for bearing capacity.
- Designs are in general accordance with NCMA's *Design Manual for Segmental Retaining Walls, 2nd Ed.*
- Reinforced and Backfill soils are to be compacted to 95% maximum dry density (Standard Proctor).
- All Belvedere Specifications are to be followed.
- Block sizes and placement shown are for reference only. Individual Belvedere Collection blocks will vary with installation pattern.

PRELIMINARY WALL HEIGHT GUIDES

This page shows preliminary guides for soil reinforcement required to construct a wall with Belvedere Collection blocks in the conditions noted below. The geogrid reinforcement is Mirafi Miragrid 2XT. The geogrid layers shall be placed with 100% coverage along the length of the wall (no gaps between sections of grid). See wall installation details for typical construction notes. As always, follow the specific requirements shown in the engineered design for your wall.

FINE TO MEDIUM SAND ($\phi = 30^\circ$, $\gamma = 120$ pcf) 1 on 3 (18.5°) BACKSLOPE NO SURCHARGE

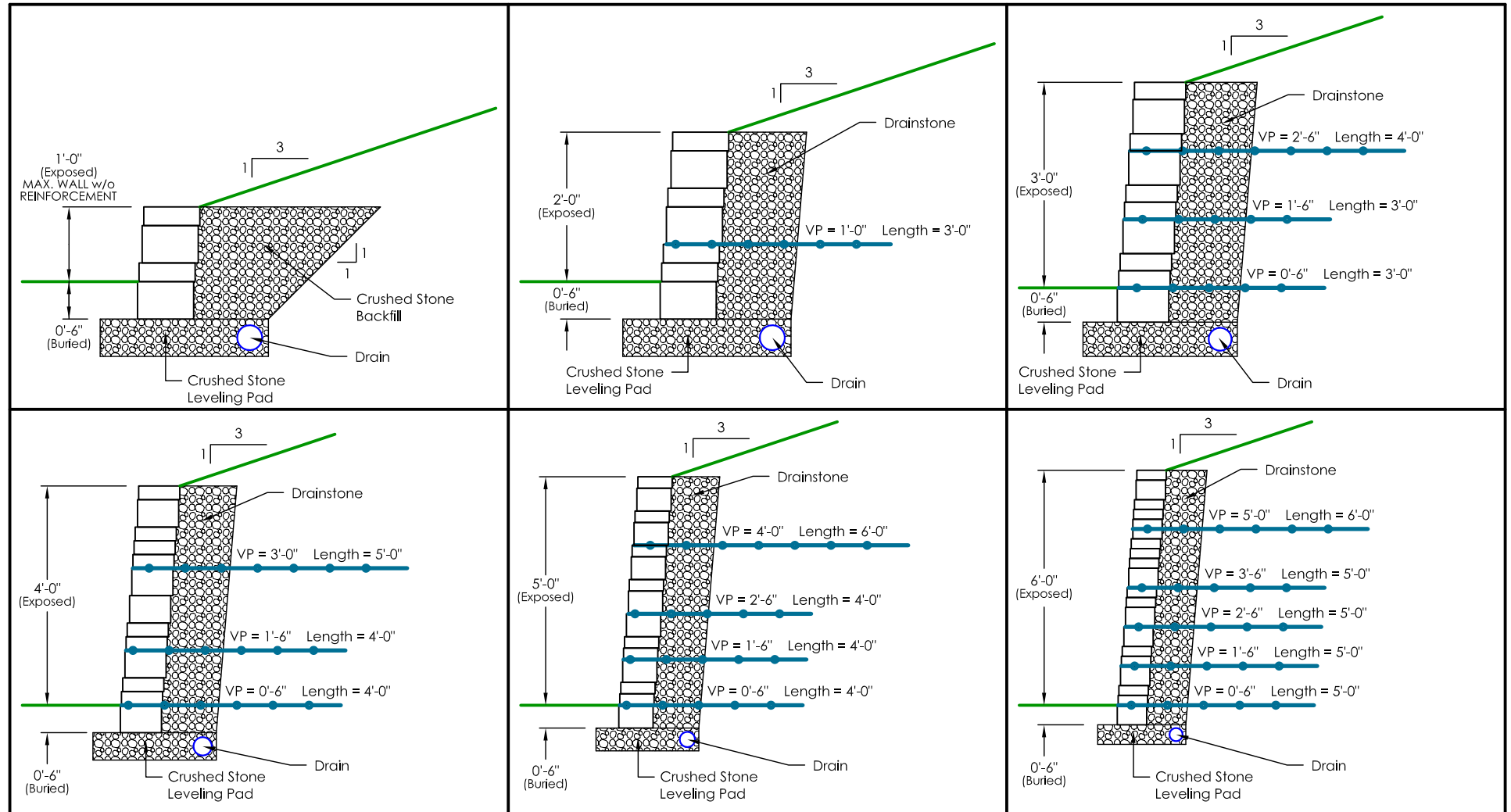

- These drawings are for reference only.
- Final designs for construction must be prepared by a registered professional engineer, using the actual conditions of the proposed site. Wall stability must be verified for site specific conditions.
- Final wall design must address both internal and external drainage and shall be evaluated by the professional engineer who is responsible for the wall design.
- Seismic conditions are not included in these guides and must be analyzed based on site specific conditions.
- Vertical placement (VP) of geogrid is measured up from the bottom of the blocks/top of the stone leveling pad.
- Length of geogrid is measured from the front of the Belvedere blocks.

- These guides assume a flat "toe" slope at the bottom of the wall. Toe slopes must be analyzed based on site conditions.
- Minimum Factors of Safety for the assumed conditions shown above are 1.5 for sliding, 2.0 for overturning, and 2.0 for bearing capacity.
- Designs are in general accordance with NCMA's *Design Manual for Segmental Retaining Walls, 2nd Ed.*
- Reinforced and Backfill soils are to be compacted to 95% maximum dry density (Standard Proctor).
- All Belvedere Specifications are to be followed.
- Block sizes and placement shown are for reference only. Individual Belvedere Collection blocks will vary with installation pattern.

TYPICAL DRAIN PLACEMENT DETAILS

This page shows typical drainage details for Belvedere retaining walls. These drawings are for reference only. Proper drainage is critical to successful wall construction. Wall drainage details need to address both internal and external drainage and shall be evaluated by the Professional Engineer who is responsible for the wall design.

Notes:

1. Clearly understand the drainage characteristics of the site, including both surface and subsurface water flow, and have a detailed plan to properly deal with any water before starting construction.
2. Install the drain in the lowest possible point behind the wall to allow the outlet pipe to drain by gravity to daylight.
3. Outlet to a storm drain system should only be made under specific design, oversight, and direction by a professional engineer.
4. Grade areas both on top and bottom of the wall to direct surface water runoff away from the retaining wall. Drainage swales may be required.
5. Use of a blanket and/or chimney drain is recommended in areas where groundwater can be expected near the bottom of the wall or flowing through the retained soil zone.

TYPICAL CRUSHED STONE LEVELING PAD MATERIAL GRADATION REQUIREMENTS	
SIEVE SIZE	% PASSING
1 1/2 INCH	100
1 INCH	95 - 100
1/2 INCH	25 - 60
NO. 4	0 - 10
NO. 8	0 - 5
NO. 200	0

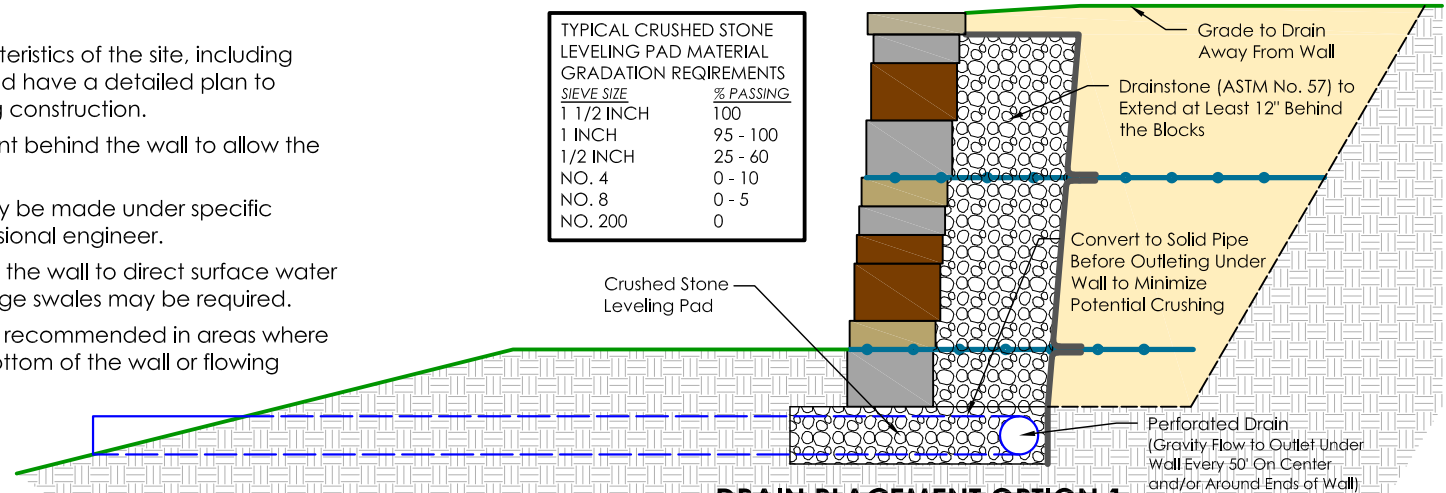

DRAIN PLACEMENT OPTION 1

THIS DETAIL IS INTENDED FOR USE WHERE GRAVITY DRAINAGE IS AVAILABLE TO THE BOTTOM OF THE CRUSHED STONE LEVELING PAD

TYPICAL DENSE-GRADED ROAD GRAVEL LEVELING PAD MATERIAL GRADATION REQUIREMENTS	
SIEVE SIZE	% PASSING
1 INCH	100
3/8 INCH	60-85
NO. 8	25-60
NO. 200	9-16

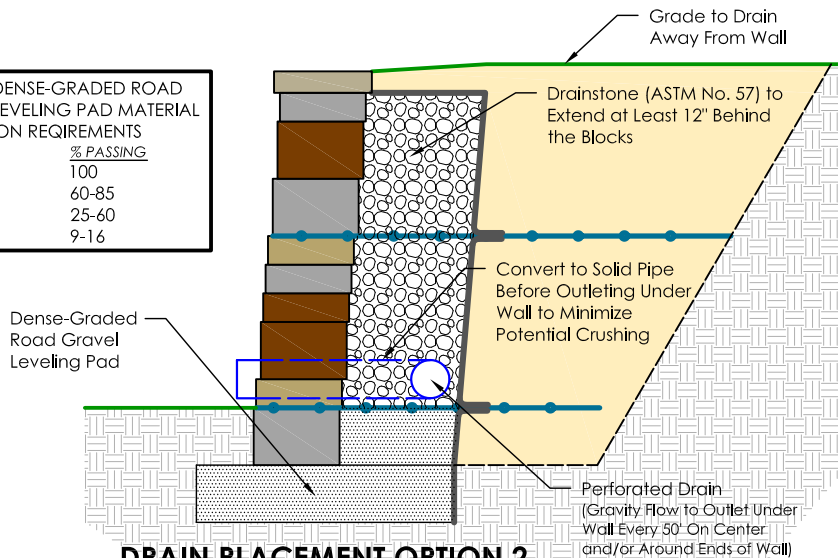

DRAIN PLACEMENT OPTION 2

THIS DETAIL IS INTENDED FOR USE WHERE GRAVITY DRAINAGE ONLY AVAILABLE TO THE BOTTOM OF THE EXPOSED WALL FACE

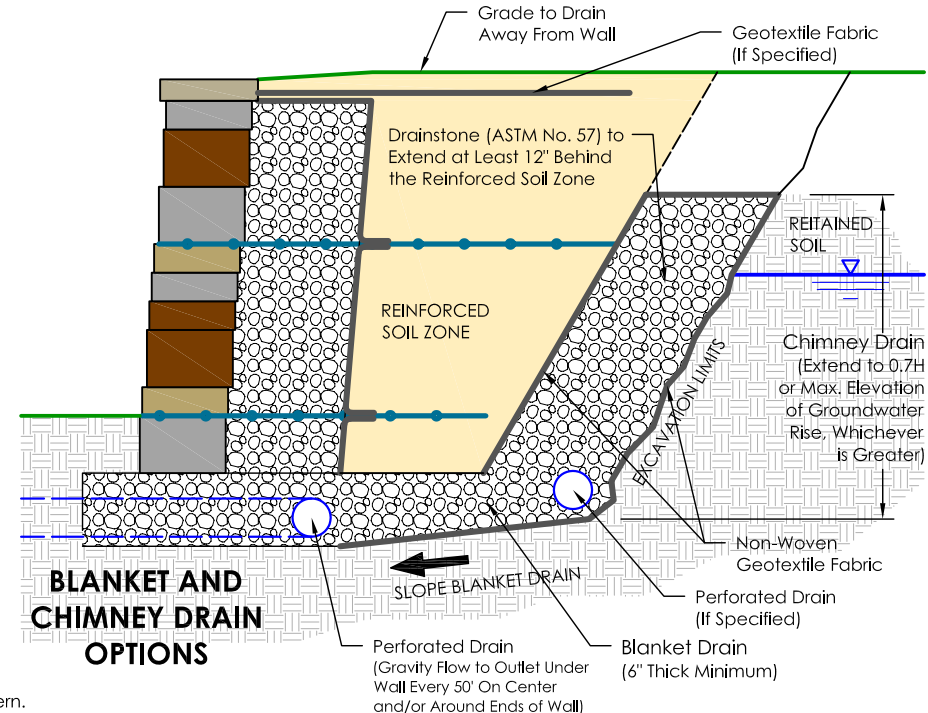

BLANKET AND CHIMNEY DRAIN OPTIONS

- This drawing is for reference only.
- Block sizes and placement shown are for reference only. Individual Belvedere blocks will vary with installation pattern.

ALSO AVAILABLE

All Rosetta products offer the beauty of natural stone with dramatically improved installation efficiency



DIMENSIONAL STEP COLLECTION



GRAND FLAGSTONE COLLECTION



OUTCROPPING COLLECTION



IRREGULAR STEP COLLECTION

- Rugged Texture
- Large Scale
- Perfect for structurally demanding applications

- Natural Texture
- Uniform Rise
- Form Meets Function

- Consistent Thickness
- Easy to Follow Pattern
- Grand Appearance



www.discoverrosetta.com

